

Design of Integrated Light Guiding Plates Using Silicon-based Micro-Features

Jyh-Cheng Yu*, Shao-Tang Zhangjian, and Zong-Nan Chen

Abstract-- This study addresses the design of an integrated light guide plate (LGP) to produce a uniform illumination with enhanced axial luminous intensity without use of prism sheets and diffusive sheets. The LGP design applies the micron-sized features fabricated from a novel stamper process that combines anisotropic wet etching of silicon-on-insulator (SOI) wafers with electroforming to fabricate and distribute truncated square pyramid prisms precisely. The truncated square pyramidal features are orientated 45° to light of travel by mask design, which provides a narrow directional luminance distribution along the axial direction similar to the use of conventional two orthogonal prism sheets. The optical software program LightTools is applied to simulate luminance performance and to optimize feature distribution. Because the feature geometry and the distribution can be accurately realized using the proposed scheme, design optimization of LGP becomes realistic. A 3.5 inch LED edge-lit LGP is used as an illustrative example. Preliminary results show an increase of average illuminance by 20% with similar on-axis luminance enhancement without any optical sheet compared with conventional BLM design.

I. INTRODUCTION

Typical back light modules (BLMs) of thin film transistor liquid crystal displays (TFT-LCDs) consist of light sources, reflecting sheets, light guide plates (LGP), diffusive sheets and prism sheets. Light guide plates (LGP) convert edge light sources, such as cold cathode fluorescent lamps (CCFLs) and LEDs, to uniform planar light by manipulating dimension and distribution of the microfeatures on the surfaces of LGP. As increasing market toward reduced thickness and to increased brightness of portable display devices, edge-lit LED and

integrated light guide plates have become two major solutions.

Conventional BLMs place lower diffusive sheets on top of LGP to convert emitting light to Gaussian distributions, and apply prism sheets to compress emitting angle distribution to axial directions to enhance brightness (Fig. 1). Design of integrated LGP aims to combine the functions of additional optical sheets into light guides to reduce the module cost. Some introduces diffusive patterns on the exit surface of LGP to eliminate lower diffusive sheets. Others propose an integrated LGP with double-sided microstructures [3] to reduce use of prism sheets. V-cuts [1] or pyramid arrays [2] are applied to the exit surface of integrated LGP to direct the emitting rays to axial directions.

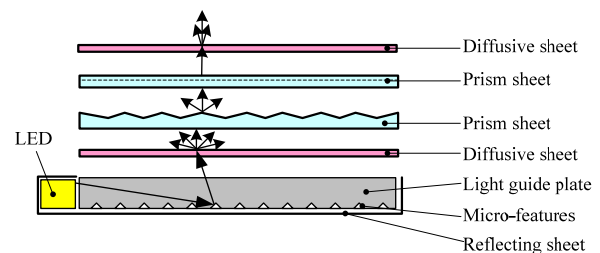

Fig. 1. Schematic diagram of an edge-lit back light module

If geometrical design of reflecting features on the bottom of LGP can control the illumination angle toward a direction perpendicular to the exit surface of LGP, prism sheets can be eliminated. Optimum distribution of microfeatures can be searched to provide uniform luminance [6][7]. The BLM will then be simplified into a single LGP and require no additional optical sheets. Also, geometrical design of micro-features for manufacturing is a key factor to close the gap between optical design and fabrication of LGP. Design optimization using simulation tools becomes futile if the feature geometry and distribution can not be precisely realized.

V-slots and square pyramids are often used in design of integrated LGPS. High-speed diamond tool machining can create micro grooves and pyramids in the injection mold and has attracted great interests from industries. However, the feature distribution is restricted to a simple matrix, which is unfavorable to the design of LED edge-lit LGP where two-dimensional feature distributions are indispensable. Additionally, the requirement of a special machining facility and diamond tool wear are significant cost concerns.

Anisotropic wet etching of silicon produces accurate V-slots and square pyramids, which in combining with electroforming can be used in fabrication of metal stamper for manufacturing of nonprinted LGPs [4][8]. Simple

Manuscript received March 10, 2009. This work was supported in part by the Ministry of Economic Affairs of the Republic of China, Taiwan under Grant 97-EC-17-A-07-S1-108 and the National Science Council under Grant NSC 96-2221-E-327-043.

Jyh-Cheng Yu is with the Dept. of Mechanical and Automation Engineering, National Kaohsiung First University of Science and Technology, 2 Jhuoyue Rd., Kaohsiung 811, Taiwan, R.O.C. (corresponding author, phone: +886-7-6011000 ext. 2228; e-mail: jcyu@ccms.nkfust.edu.tw).

Shao-Tang Zhangjian is with the Dept. of Mechanical and Automation Engineering, National Kaohsiung First University of Science and Technology. (e-mail: wsm70174@yahoo.com.tw).

Zong-Nan Chen is with the Dept. of Mechanical and Automation Engineering, National Kaohsiung First University of Science and Technology. (e-mail: kupt84@yahoo.com.tw).

geometry and high repeatability of silicon-based features greatly improves simulation accuracy and facilitates the realization of design optimization. However, sharp tips from simple silicon etching are unfavorable to mold life and molding part quality.

The feature design and distribution of the integrated LGP are two key topics for high brightness and illumination uniformity. This study applies anisotropic etching of silicon on insulator (SOI) wafer and electroforming to make stampers with precision truncated square pyramidal microfeatures that will be used in production of nonprinted LGPs. The optical software program LightTools is applied to simulate luminance performance of BLM, and to optimize feature distribution. Different orientations of the truncated square pyramid will be attempted to control the distribution of emitting angles.

II. FABRICATION OF LGP STAMPER

The etched geometry is bounded by (111) crystalline planes for wet chemical etching of silicon substrate using anisotropic etchants such as aqueous KOH and TMAH (Fig. 2). This study controls etching depth by specifying the device layer thickness of <100> SOI wafer to fabricate precise truncated square pyramids[9]. The vertex angle of the pyramid is 70.5°. The etched wafer is then deposited thin metal layers as the initial cathode for electroforming. Nickel based electroforming is used to transcribe the silicon features into metal stamper followed by backside grinding to designated thickness and flatness. The nickel stamper is finally released using KOH wet etching. Mask alignment are designed to produce square pyramids of different orientations.

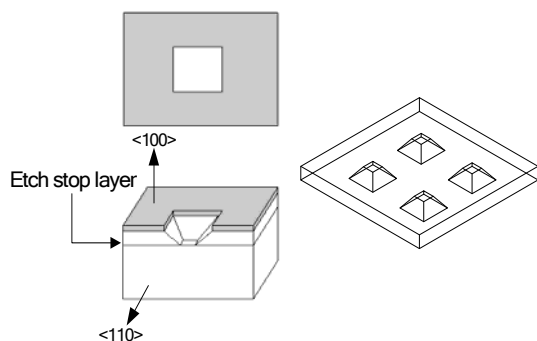

Fig. 2. Mask designs and (a) truncated square pyramid feature from anisotropic etching of <100> wafers (b) corresponding stamper after electroforming

Fig. 3 is a SEM photograph of a sample Ni stamper with truncated square pyramids. Truncated pyramids, instead of sharp tips, reduce mold wear and improve transcribing accuracy when injection molding of an LGP. The height of truncated pyramid can be accurately controlled by the thickness of the device layer of SOI wafer. The proposed stamper fabrication process guarantees extremely high geometrical and dimensional accuracy of the injection mold. Since smaller features improve luminous uniformity, the base width of the truncated square pyramids is set as 10 μm . Consider the transcribing limit of injection molding for a well-controlled geometrical feature, the

width of the truncated tip is assumed to be $2 \times 2 \mu\text{m}$ by selecting the device layer thickness of SOI to 5 μm .

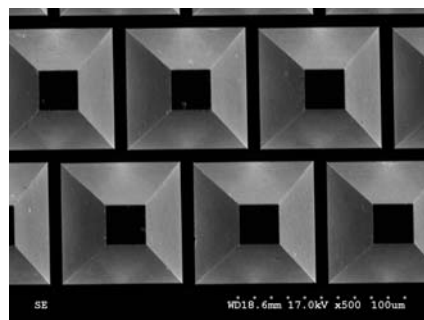

Fig. 3. SEM micrograph of the electroformed stampers from anisotropically etching a <100> SOI wafer.

III. DESIGN OF INTEGRATED LGP

A. Establishment of BLM model

The design of a 3.5" LED edge-lit LGP is investigated. The dimension of the LGP is $73 \times 58 \times 0.76$ (mm). Six white light LEDs are arranged on the long side of LGP. The luminous flux of a LED is 4.238 (lm). The micro-feature used in the reflective side of the integrated LGP is a $10 \times 10 \mu\text{m}$ truncated square pyramid from the proposed stamper fabrication process. An optical ray-tracing simulation tool, LightTools, is applied to distribute features and simulate the illumination performance of the BLM. To balance simulation accuracy and efficiency, one million ray-tracing is used in the following analysis.

B. Design of the light entrance surface of LGP

Unlike CCFL providing a near linear light source, light distribution of LED is more like a point light source with limited emitting distribution angle. Fig. 4 shows the illuminance distribution of a LED edge-lit LGP with uniform feature distribution. Obvious bright zones exist in front of LEDs. To increase the illumination angle of LED, prism designs are introduced to the light entrance surface of LGP (Fig. 5). Investigations show that prisms with angle of 90° and depth of 30 μm provide a better result (Fig. 6).

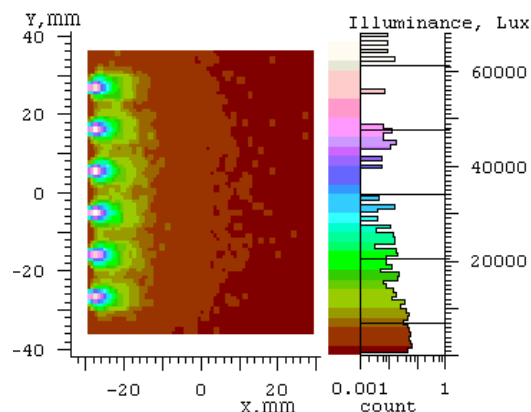

Fig. 4. Illuminance mesh of an LGP without prism designs on the light entrance surface of LGP.

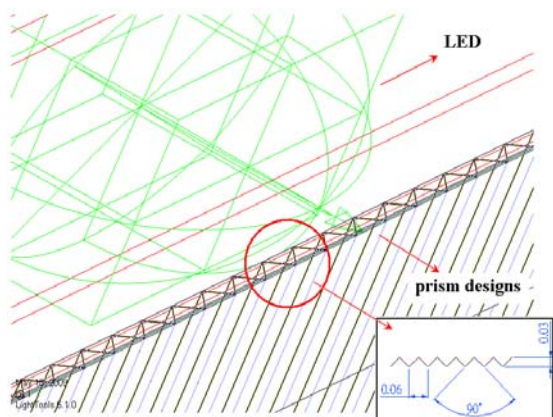

Fig. 5. Schematic diagram of an LGP with prism designs on the surface of LGP adjacent to light sources.

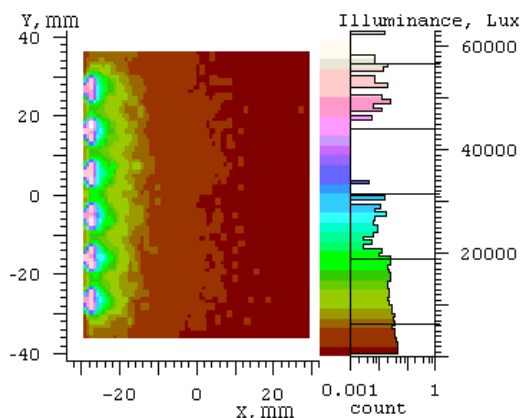

Fig. 6. Illuminance mesh of an LGP with $90^{\circ} \times 30 \mu\text{m}$ prism designs on the light entrance surface of LGP.

C. Simulation of conventional BLMs

Typical LGPs adopt diffusive dots to obtain uniform luminous distribution. Two prism sheets are added atop to compress emitting angle distribution to axial directions (Fig. 7). A comparative design is shown in Fig. 8 which adopts a uniform spacing of 0.5 mm. Dot diameters are manipulated to obtain uniform luminous distribution. The intensity distribution using LightTools simulation is shown in Fig. 9(a). The ray efficiency is 80%, and the average illuminance is 5078 (Lumen) with the standard deviation of 323(Lumen). The red line (0° — 180°) is the emitting luminous intensity transverse to light travelling, and the blue line (90° — 270°) stands for the intensity distribution along the light travelling. The distribution is approximately Gaussian, and slants toward the other side of light sources. If the LEDs are arranged at the bottom of LGP, the peak intensity appears at 40° upward. Lower diffusive sheets are often applied to modify the distribution to Lambertian.

The intensity distribution of conventional LGP is shown in Fig. 9(b) if two orthogonal prism sheets are added atop (Fig. 8) to enhance axial intensity. The viewing angle becomes approximate $\pm 25^{\circ}$ along axial direction. The axial luminous intensity increases from 5 (cd) to 15 (cd). The peak intensity is as high as 18.97(cd), but appears at 30° upwards. The average illuminance is 4310 (Lumen) with the standard deviation of 175(Lumen). The ray efficiency decreases to 72% due to the reflection and

absorption loss of prism sheets. Prism sheets effectively enhance axial intensity with additional costs and module thickness.

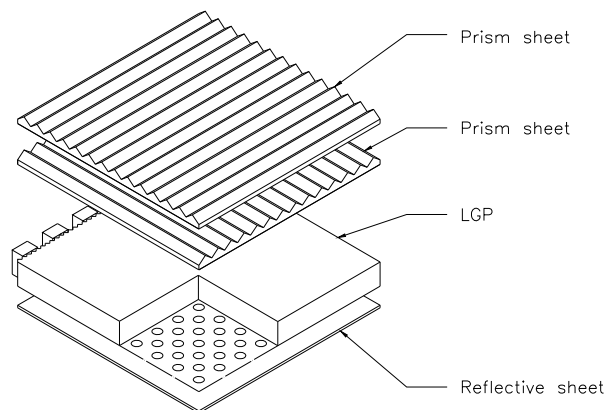

Fig. 7. Schematic diagrams of conventional BLM consisted of an LGP with diffusive dots and two prism sheets.

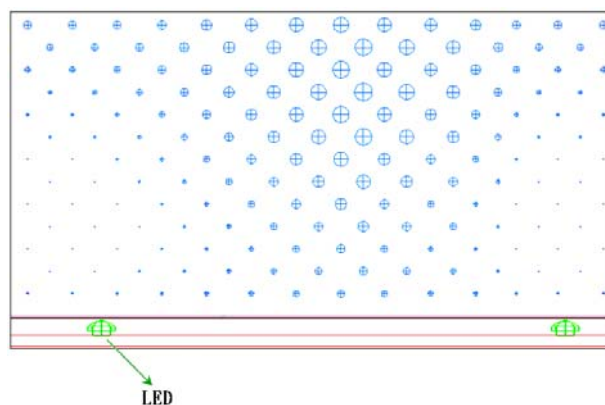

Fig. 8. Schematic diagram of an LGP with circular diffusive dots of various diameters.

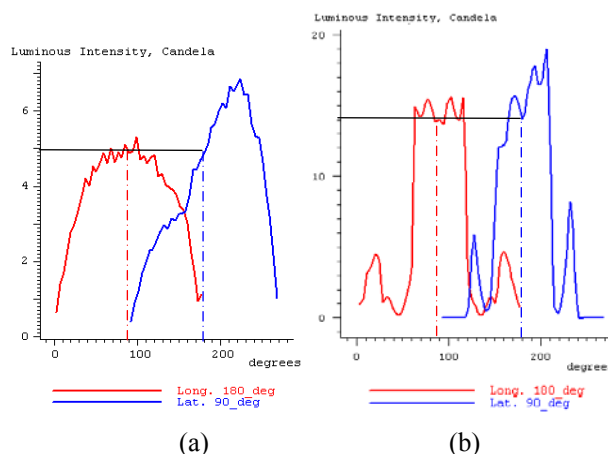

Fig. 9. Intensity mesh of an LGP with circular diffusive dot design (a) without any optical sheet, and (b) with two orthogonal prism sheets.

D. Design of integrated LGPs

The proposed stamper fabrication process produces precisely truncated square pyramids. This study manipulates the spacing among features using the optimization function of LightTools to obtain uniform luminous distribution. Fig. 11(a) shows the intensity

distribution of an LGP using truncated square pyramids. However, the intensity at the axial direction reduces drastically in the transverse section, and the peak intensity along the light travelling still slant upward as conventional LGP with diffusive dots (Fig. 11-a).

As we reorient the pyramids 45° to the light sources as shown in Fig. 10(b), a narrow directional luminance distribution along the axial direction similar to conventional LGP with two orthogonal prism sheets presents (Fig. 11-b). Furthermore, the density distributions are symmetric, and the peak luminous densities appear at the axial direction, which is very important for the displays of personal portable device. This attractive optical performance will provide the best brightness enhancement in the viewing angle without use of any prism sheets[10]. For a fixed geometry of truncated square pyramids, the reflecting luminous flux will be in proportional to the density of microfeatures. The features on LGP are distributed using the optimization function of LightTools to obtain uniform illuminance (Fig. 12), and the preliminary result of illuminance distribution is shown in Fig. 13.

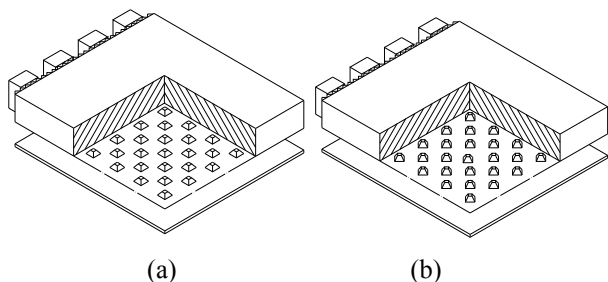

Fig. 10. Schematic diagrams of an LGP with (a) truncated square pyramidal features and (b) 45° oriented truncated square pyramidal features.

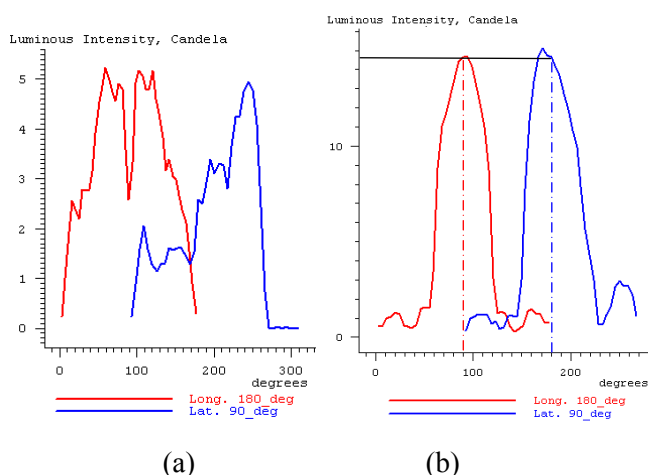

Fig. 11. Intensity mesh of an integrated LGP with (a) truncated square pyramidal features and (b) 45° oriented truncated square pyramidal features.

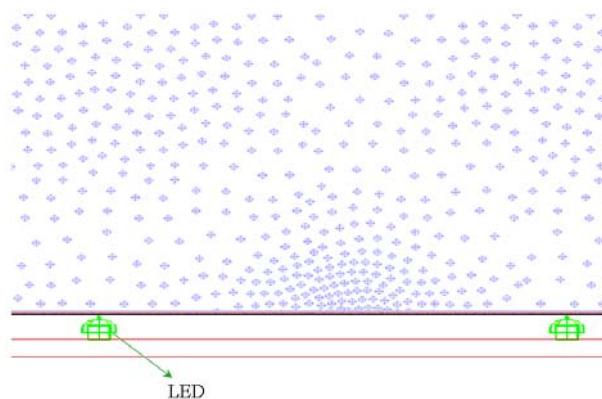

Fig. 12. Schematic diagram of an integrated LGP with distributed 45° oriented truncated square pyramids.

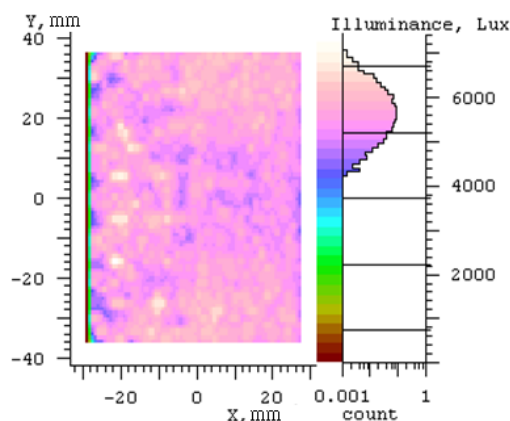

Fig. 13. Illuminance mesh of a optimized distribution design of 45° oriented truncated square pyramidal features on an LGP.

E. Comparison of results

The optical performances of conventional BLMs and the proposed integrated LGP are compared in Table 1. The average luminance and uniformity were determined by conventional 9-point measurement. Prism sheets can enhance axial luminous intensity about 200% for LGP with diffusive dots. Based on the optimization results using LightTools, LGPs with diffusive dots and two prism sheets did provide a better average luminance and uniformity. However, the proposed integrated LGP has a better ray efficiency and delivers 20% higher average illuminance compared with conventional BLMs. Also, the axial luminous intensity of the integrate LGP is as high as conventional BLMs without use of prism sheets. Though the luminance uniformity of the integrated LGP is only 82% due to the limits of the optimization module of LightTools, it can be improved by other optimization schemes such as fuzzy optimization [5].

Table 1. Comparison of optical performance of a conventional BLM and the integrated LGP

	Ray Efficiency	Average Illuminance (Lumen)	Standard Deviation (Lumen)	Axial Luminous Intensity (cd)	Average Luminance (cd/m ² ,nit)	Luminance Uniformity
Dotted LGP	80%	5078	323	~5	1217	68%
Dotted LGP with 2 BEFs	72%	4310	175	~15	3582	93%
Integrated LGP	88%	5189	474	14.8	3236	82%

IV. CONCLUSION

An integrated LGP based on a silicon-based micron features was presented. The microfeatures of truncate square pyramid are attractive because of high geometrical and dimensional accuracy and superior feasibility for non-printed LGPS. By orienting the pyramids 45° to light of travel, the proposed LGP provides a narrow directional luminance distribution along the axial direction similar to the use of conventional two orthogonal prism sheets. Also, the integrated LGP design provides a better ray efficiency. By optimizing the distribution density, the proposed design can replace conventional LGPs and prism sheets to deliver high axial luminance and uniformity with a lower cost. The simulation results using LightTools confirm the feasibility and the attractive advantage of the proposed design.

REFERENCES

- [1]. Feng, D.; Jin, G.; Yan, Y., and Fan, S., High quality light guide plates that can control the illumination angle based on micropism structures, *Applied Physics Letters*, Volume 85, Issue 24, id. 6016 (2004).
- [2]. Chien, C.-H. and Chen, Z.-P., Fabrication of a novel integrated light guiding plate by microelectromechanical systems technique for backlight system, *J. Microlith., Microfab., Microsyst.*, Vol. 5(4), pp. 043011-1~043011-6, 2006.
- [3]. Shinohana, M. and Aoyama, S., "Surface light source device, elements therefor and apparatus using the SAME", 2001/5/15, US pattern 6231200.
- [4]. Lin, L., Shia, T. K. and Chiu, C.-J., Silicon-proceed plastic micro pyramids for brightness enhancement applications, *J. Micromech. Microeng.* 10, 395-400, 2000.
- [5]. Yu, J.-C. and Hsu, P.-K., Design Optimization and Stamper Fabrication of Light Guiding Plates Using Silicon Based Micro-Features, *Proceedings of the Symposium of Design Test Integration and Packaging (DTIP) of MEMS and MOEMS*, Rome, Italy, 1-3 April 2009.
- [6]. Chang, J.-G., Lee, C.-T., Fang, Y.-B. and Hwang, C.-C., Generation of random non-overlapping dot patterns for light guides using molecular dynamics simulations with variable r-cut and reflective boundary techniques, *Computer Physics Communications*, Vol. 177, pp.851-862, 2007.
- [7]. Taniguchi, H. and Hira, Y., Liquid crystal display device, US pattern 6099134, 2000/8/8.
- [8]. Taniguchi, H. et al., Method for manufacturing a light guide plate, US pattern 6704070B2, 2004/3/9.
- [9]. Yu, J.-C. and Li, P.-J., Fabrication of LGP stamper using anisotropic etching of silicon wafers with depth etching stop as the initial electroforming cathode, ROC patent pending, No. 96100909.
- [10]. Yu, J.-C. and Zhangjian, S.-T., Design and Fabrication of an integrated LGP with enhanced axial luminous intensity, ROC patent pending.